Installation & Operation Manual

Swimming Pool Air Source Heat Pump

Model Number : YC-025TA1



Thank you very much for purchasing our product, please keep and read this manual carefully before you install heat pump.

Company:







Add:

Tel:

Web:

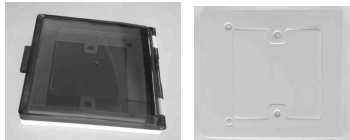
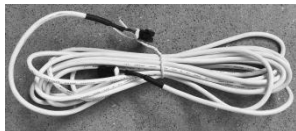
Email:

Packing List

No.	Name	Qty.	Remark
1	Installation & Operation Manual	1	
2	Wire-controller	1	
3	Wire controller box and sponge pad (Will install on the heat pump shell)	1	
4	Wire-controller Cable	1	
5	Drain-pipe (2 m)	1	
6	Drain-pipe connector	1	
8	Rubber shock absorber	4	
9	Heat Pump Unit (The pipe connector has been installed on the machine)	1	

Please keep installation manual properly, and read it carefully before using.

 The unit must be installed by professional personnel, and install it based on this manual as possible.

 Special reminding: if the unit would be installed where is vulnerable to lightning stroke, lightning protection measurements must be carried out.

 Special reminding: The unit is not suitable for using in the winter, the water reserved in the pipe network system must be drained.

Content

Accessories description.....	4
Attention for safety.....	5
Heat pump unit working principle.....	6
Installation of the unit.....	8
Installation of the pipeline.....	11
Installation of optional accessories.....	13
Installation and operation of electric devices.....	14
Instruction of operation	18
Adjusting and Initial operation.....	31
Operation and maintenance.....	32
Fault analysis and elimination method.....	34
Technical parameter.....	35
After-sale service.....	35

1. Accessories description

Each unit produced by our factory is with the following accessories:

No.	Name	Qty.	Use
1	Installation & Operation Manual	1 PC	Guide users to install the system
2	Wire controller	1 PC	Used for the man-machine operation interface
3	Wire controller connecting cable	1 PC	Connect wired controller to heat pump unit
4	Drain-pipe	1 PC	Used for draining the condensate water
5	Drain-pipe connector	1 PC	Connect the drain pipe to the heat pump unit
6	Power cable	1 PC	Power cable for the heat pump unit
7	Rubber shock absorber	4 PCS	Reduce vibration and reduce noise
8	Heat pump unit	1 SET	For heating water

For function you need to purchase at least the following parts for each unit:

No.	Name	Qty.	use
1	Water pump	1	Cycle the heated water
2	Filter system	1	Protect the heat pump from pool water
3	Water pipes system	1	Connect the equipment and make circulation

▲ NOTE

The types and quantity of the water pipes, valves, filter equipment, sterilizing equipment which used for the swimming pool heating/circulation pipe system, depend on the project design. We do not suggest to install auxiliary electric heaters in the system. If must install auxiliary electric heaters, must install the electric heaters by the specialized persons, and our company has no responsibility for all the problem cause by the auxiliary electric heater.

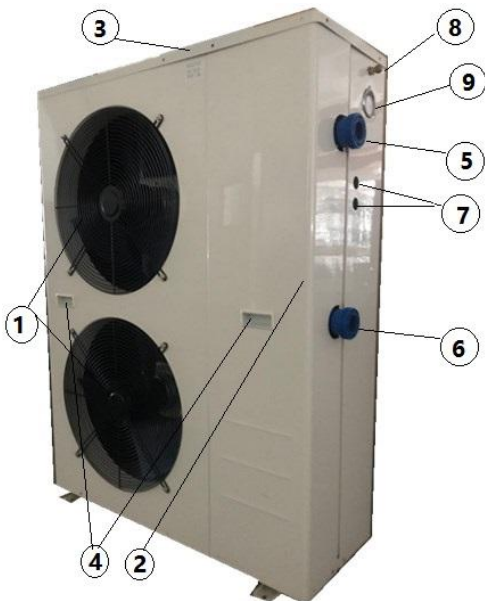

NO.	Name	Quantity	Unit
1	The front air-out screen	2	PCS
2	Front right panel	1	PCS
3	Up cover panel	1	EA
4	Large pumping hands	2	EA
5	Upwards cycle hole	1	EA
6	Downwards cycle hole	1	EA
7	Cable waterproof connector	2	EA
8	Shut-off valve	1	EA
9	Pressure gauge	1	EA

2. Attention for safety

Range of application:

- 1.Power supply: 380-415V/3N~50Hz.
- 2.Environment temperature: $-15^{\circ}\text{C}\sim 43^{\circ}\text{C}$:
- 3.Working water temperature: Min. inlet water temperature 8°C , Max. outlet Water Temperature 40°C . If the system is always used beyond the available water range, please contact with manufacturer.

- The installation shall be done by the professional persons, to prevent leaking, electric shock, or fire disaster.
- Confirm the ground connection, if the ground connection is not correctly done, it may cause electric shock.



- When install the heat pump in a small room, must keep well ventilated.
- Don't put finger or sticker into the air inlet or air outlet. Because the internal rotor high-speed operation may cause injury.
- When an exception happens (burning smell), turn off the manual power switch immediately, stop operating, and contact with after-sale service department. If continue the abnormal operation, it may cause electric shock or fire disaster.
- When the unit needs to be removed or re-installed, please entrust after-sale service department and specialized personnel to do it. If the installation is not well done, it may cause unit operation failure, electric shock, fire, hurt, leaking, etc.
- Must not be unauthorized reformed, otherwise it may cause electric shock or fire.

-
- When needs to be repaired, please entrust after-sale service department or a specialized personnel to implement. If improper repaired, it may cause unit operation failure, electric shock, fire, hurt, leaking, etc.
 - Can not install the unit in combustible gas easy-leaking places, once the combustible gas leaks around the unit, it may cause a fire.
 - Confirm if the installation base is strong enough, if it is not strong and has been used for a long time, it may cause falling and injuries.
 - Confirm if leakage protection switch is installed, if don't install a leakage protection switch, may cause electric shock or fire.
 - When cleaning the unit, the operation should be stopped, and power switch should be turned off.

3. Heat pump unit working principle

3.1 Heat pump working process

- First, the low pressure and superheated gas in the evaporator is inhaled into the compressor then becomes the high temperature and high pressure overheated vapour.
- Second, the overheated vapour is exhausted into the condenser and exchange the heat with the water, then the refrigerant is condensed and becomes the saturated or over cooling high pressure and high temperature refrigerant liquid. The water is heated up by heat pump when absorbing the heat energy which released by the refrigerant.
- Third, the refrigerant liquid releases the pressure by passing the expansion valve, then becomes the low temperature and low pressure liquid.
- Fourth, the refrigerant liquid flows into the evaporator and absorb the energy from the air, then is vaporized and became the low pressure and overheated vapour. The refrigerant working repeatedly as described above, then the water which flows through the condenser is heated up constantly, the temperature rise and can get the hot water.

3.2 Air source heat pump working principle

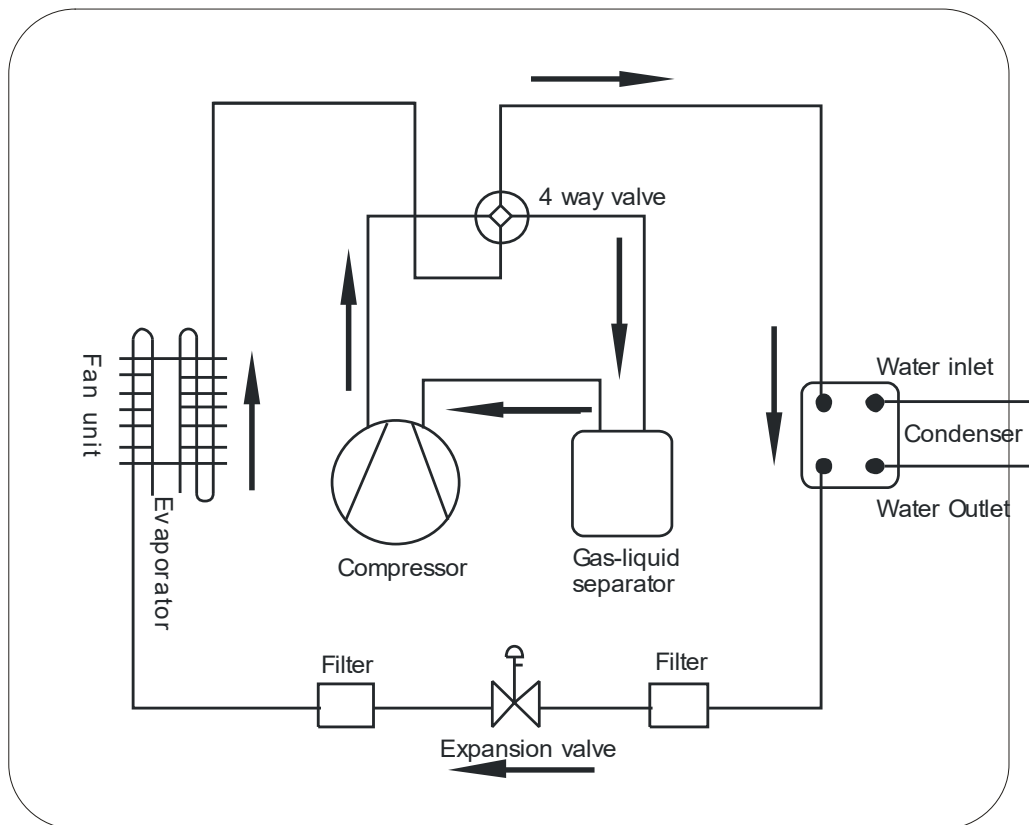

Figure 1

Q_c (Heat energy get) = Q_a (Compressor consumption) + Q_b (Heat energy absorbed from ambient environment)

3.3 Heat pump performance curve for variable working condition

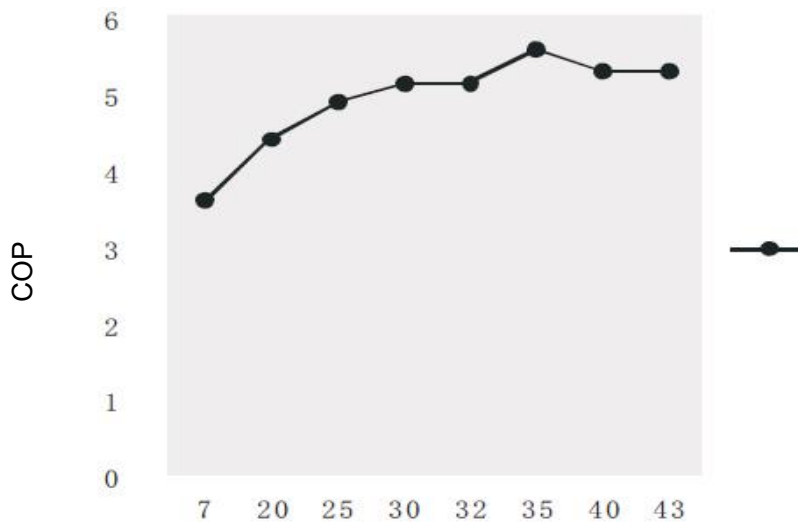

Figure 2

Environment temperature (°C)

Attention pipeline anti-freezing in case the environmental temperature drops to 0°C.

4. Installation of the unit

4.1 Installation attention

- Avoid installations in such locations with mineral oil.
- Avoid installation in locations where air contains salt or other corrosive gas.
- Avoid installation in locations with serious power supply voltage fluctuation.
- Avoid installation in an unstable place, such as car or cabin
- Avoid installation near flammable items.
- Avoid installation in locations with strong electromagnetic wave.
- Avoid installation in locations with special harsh environmental conditions.

4.2 Installation check

- Check the model, number, name etc, avoid incorrect installation.
- Make sure enough space for installation and maintenance.
- Make sure barrier-free for air inlet and outlet, also dry ventilated place.
- Make sure the bearing surface can meet the requirement and avoid shocks.
- The power supply and its capacity, wire diameter choice should be in accordance with the electrical installation requirements.
- Electrical installation must comply with the relevant technical standards of electrical equipment, and electrical insulation work must be done.
- The unit must be power on for at least eight hours before running and debugging.

4.3 Installation space

Keep the following indicated space for operation and maintenance first before installation

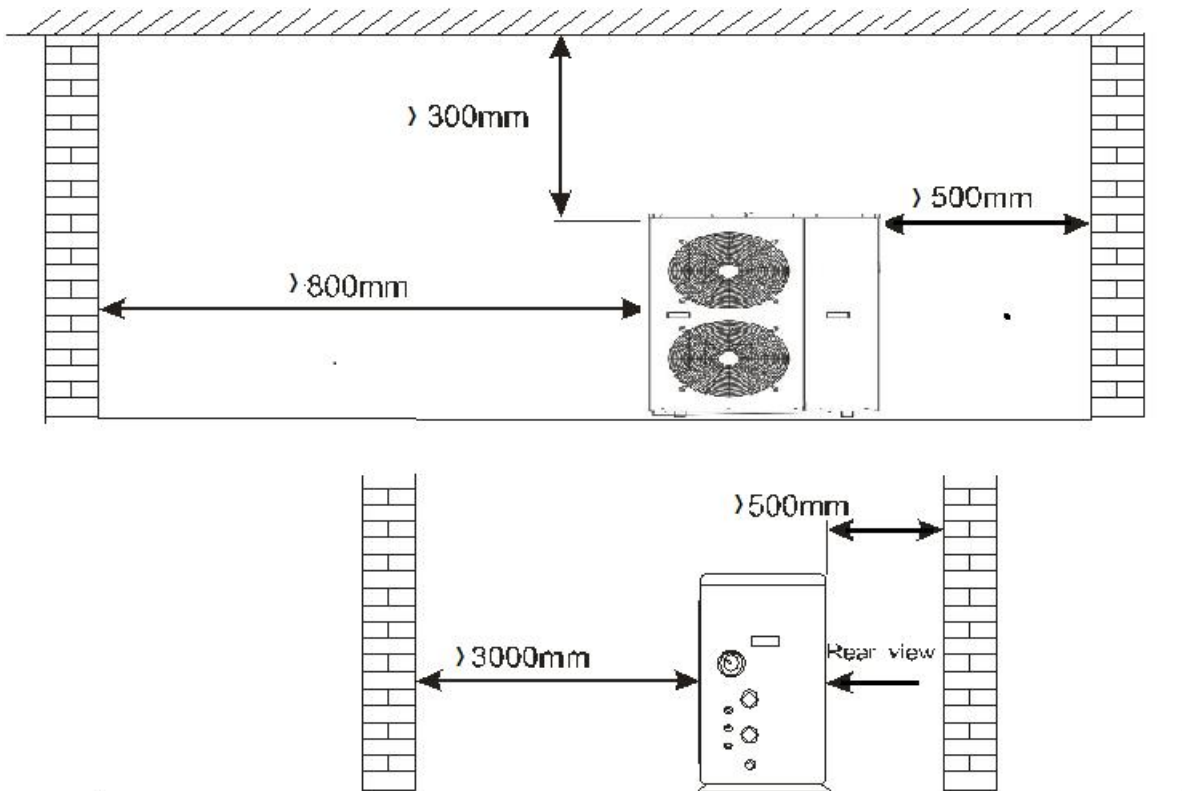

Figure 3 Horizontal type installation space (units: mm)

4.4 Heat pump unit size

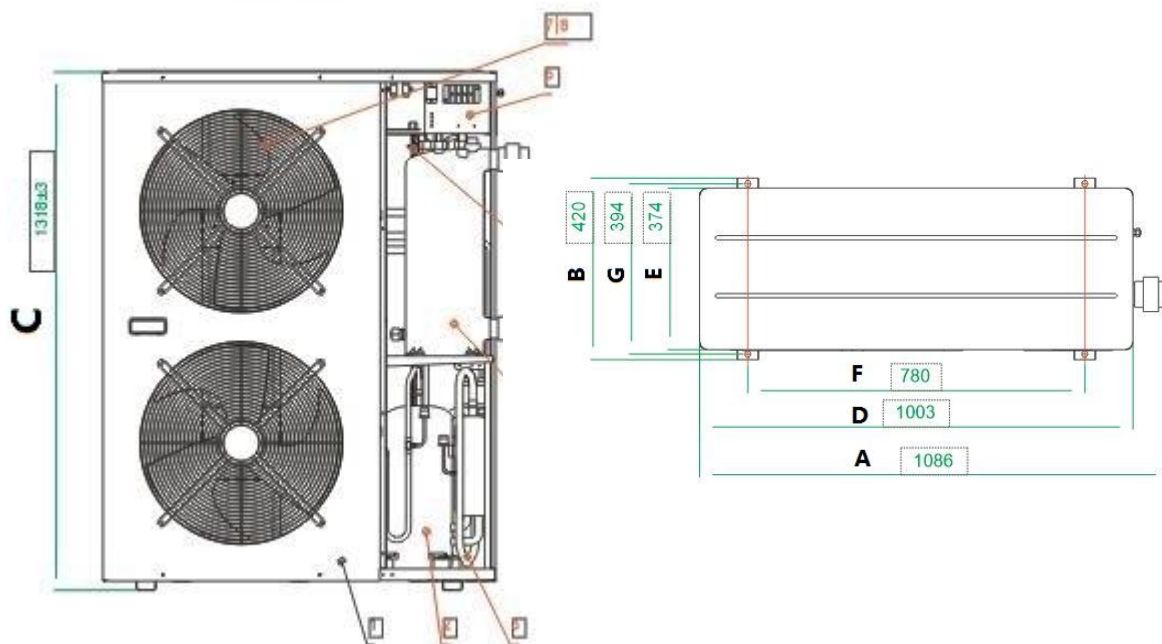

Figure 4 Horizontal type heat pump size

Size(mm) Model No.	A	B	C	D	E	F	G
YC-025TA1	1086	420	1318	1003	374	780	394

4.5 Reserve the installation base for the heat pump

Please refer to Figure 5.

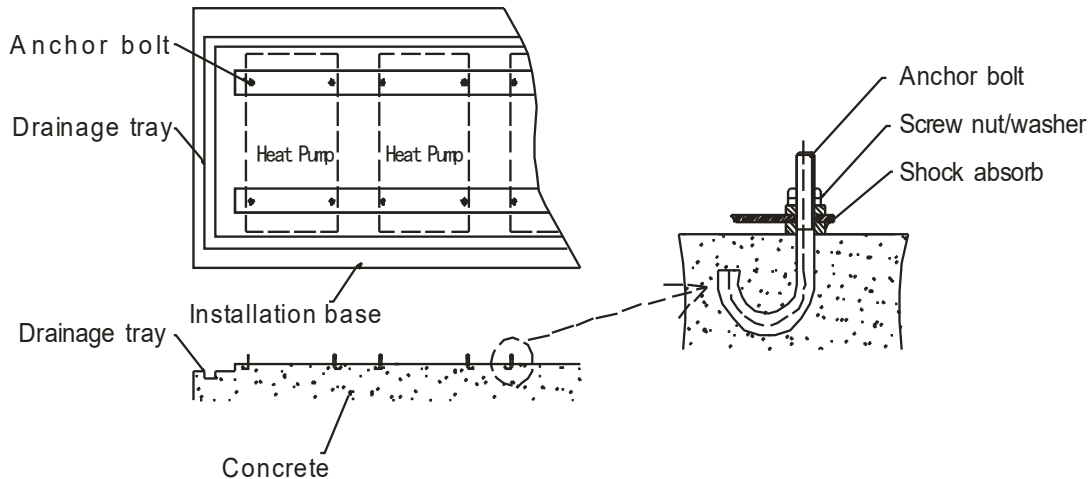

Figure 5 Reserved installation base

4.6 Hoisting attention

- Please use four or more soft lifting belts to move the sets Figure 6.
- Please use protective plate on the surface of the sets when moving, to avoid scratch and deformation.
- Recheck whether the foundation is correct before hoisting the unit.
- The heat pump will produce condensation water, please consider the drainage channel when make the installation base.
- Please put shock absorb on base surface.

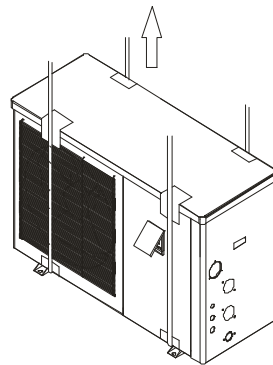

Figure 6 Hoisting diagram

5. Installation of the pipeline

5.1 Attention

- Prevent air, dust and other sundries from going into the water pipes.
- Fix the whole system before install the water pipes.
- Water inlet and outlet pipes shall be protected by the insulation layer.
- Stable water velocity shall be ensured, so that excessive throttling can be avoid.
- When moving, water inlet and outlet pipe shall not be used for hanging, only the holes on the beam of the base can be used, please refer to Figure 9
- When connect the water inlet and outlet pipes, two pipe wrenches shall be used to control the two parts of the pipes, and ensure the water inlet and outlet pipes not turning around, please refer to the Figure 7

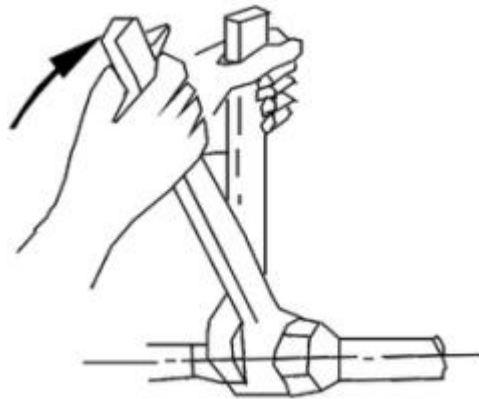















Figure 7

5.2 Instruction

5.2.1 Marginal data

												
Valve	Filter	Flexible connection	Check valve	Pump	Air valve	Pressure gage	Flow switch	Feeding tank	Flared joint	Hair collector	Sand Filter	Chemical dosing system

5.2.2 Pipeline installation diagram

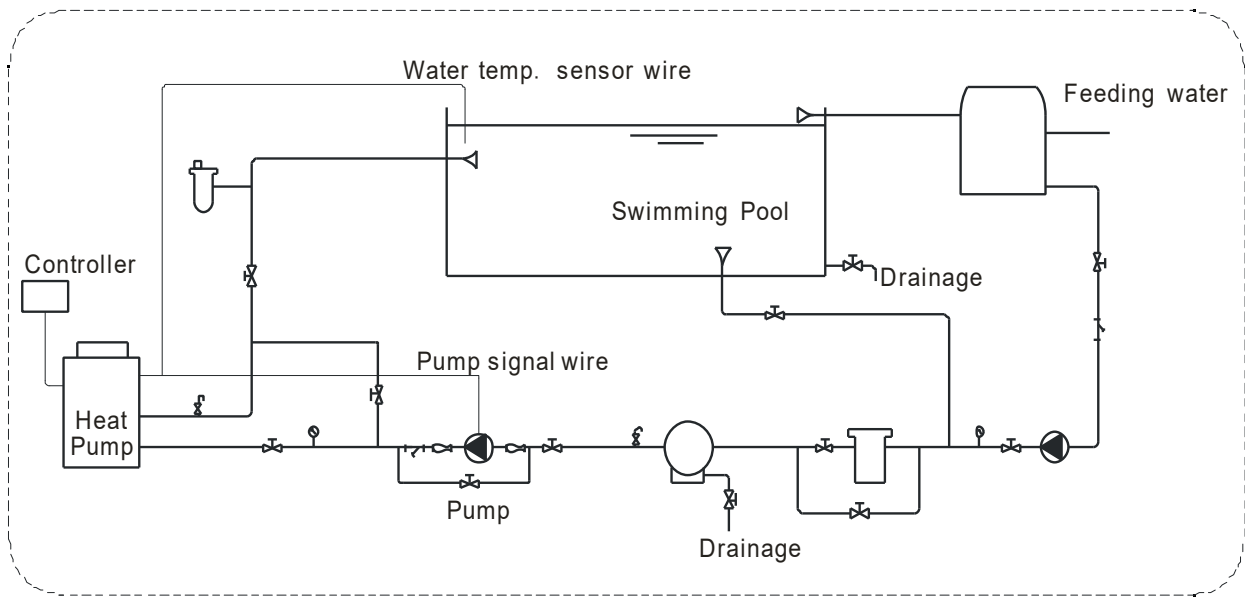

Figure 8 Diagram (Single unit for reference)

- The one-way valve is suggested for each unit, to prevent the water back flow.
- The system can be combined with multiple units, but should be controlled by each unit independently.
- Regarding the installation of backup pump, maintenance valve and temperature measure point, please consider it yourself.
- All pipes and valves of the unit need the heat preservation.

5.2.3 Selection of the water pipes

Model No.	Inlet	Outlet
YC-025TA1	DN50	DN50

The swimming pool heat pump adopt the titanium heat ex-changer, can connect the swimming pool directly, but must install a water filtration equipment before water go into heat pump, the filter meshes is about 40 meshes.

Main pipe diameter selection of the parallel connected multiple units (example)

Inlet/outlet pipe	YC-025TA1	One unit	DN50
Inlet/outlet pipe	YC-025TA1	Two units connection	DN65
Inlet/outlet pipe	YC-025TA1	Three units connection	DN80
Inlet/outlet pipe	YC-025TA1	Four units connection	DN80
Inlet/outlet pipe	YC-025TA1	Five units connection	DN100

- The pipe press and flow rate should be calculated before the diameter selection, the range of pressure drop is 0.3~0.5 kgf/cm²(3~5m) the range of head pipe flow rate is 1.2~2.5 m/s.

- The hydraulic calculation should be made after the selection of pipe diameter, if the resistance is more than pump head, then need to choose a more power pump, or choose a bigger pipe.

5.2.4 The demanded quality of water

- The bad quality water will produce more scale and sand, so this kind of water should be filtered and demineralized.
- The water quality should be analyzed before system running, to measure the PH value, conductivity, Chloride ion concentration and sulphate ion concentration.
- The acceptable water quality standard is showed as below table.

PH value	Total hardness	Conductivity	Sulphate ion	Chlorine ion	Ammonia ion
7~8.5	< 50ppm	<200 μ V/cm(25 $^{\circ}$ C)	None	< 50ppm	None
Sulfate ion	Silicon	Iron content	Sodium	Ca	
< 50ppm	< 50ppm	< 0.3ppm	No requirement	< 50ppm	

- Suggest the filter meshes is about 40 meshes.
- Must install the sand filter, hair collector etc. Swimming pool special impurity filter equipment.

6. Installation of optional accessories

6.1 Selection of the water pump

- The circulation pump is needed for the system, the power port is prepared for the pump, (one phase)

⚠ NOTE

For the single phase pump, please check the circuitry diagram.

- The head of circulation pump = height difference between water level and main unit + total pipelines resistance (determined by the hydraulic calculation) + pressure loss of main unit (see the nameplate on heat pump).

⚠ NOTE

when multi paralleled, the water pump head is subject to the worst working condition loop.

6.2 Selection of the flow switch

- The selection of the flow switch is based on the actual system, the target flow switch is recommended. Temperature of fluid: 0-120 $^{\circ}$ C , max working pressure 13.5 bar.
- The flow switch can be installed on the horizontal pipeline or the vertical pipeline which the fluid

flow direction is upward, but should not be installed on the vertical pipeline which the fluid flow direction is downward.

- The flow switch must be installed on a straight pipeline, there must be more than five times the length of the pipe diameter at its two sides. And, the direction of fluid must follow the arrow on the controller. The terminal block should be in an easy operation position, (Figure 10)
- The pannier is absolutely forbid to touch the flow switch floor, or the switch will be deformed and invalid, (Figure 8)
- Please be sure that the model of target sheet is determined by the system rated flow, diameter of outlet pipe and the adjustable range of the target(see the user manual). And the target sheet can not contact the inwall of pipe or other throttlers in pipe, or will cause the switch can not reset.

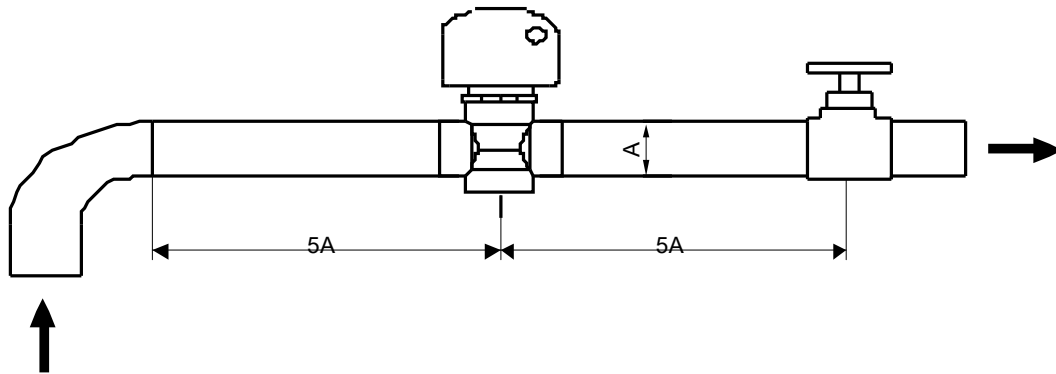

Figure 9

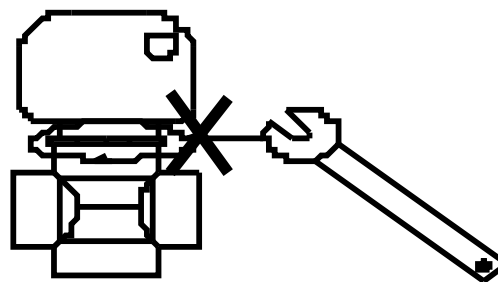

Figure 10

7. Installation of electric devices

7.1 Electrical wiring

- The unit should use a dedicated power supply, power supply voltage with rated voltage.
- Unit power supply circuit must be ground, power supply wire and external grounding reliable connection, and the external grounding is effective.
- Wiring must be constructed by the professional installation technicians in accordance with the circuit diagram.

- Power line and signal line layout should be neat, reasonable, can not interfere with each other, but not with the connecting pipe and the valve body contact.
- If the unit is not matching the power line, please supply specifications refer to provisions, wires connecting is not allowed.
- After all wiring construction is completed, please check it before switch on the power supply carefully.

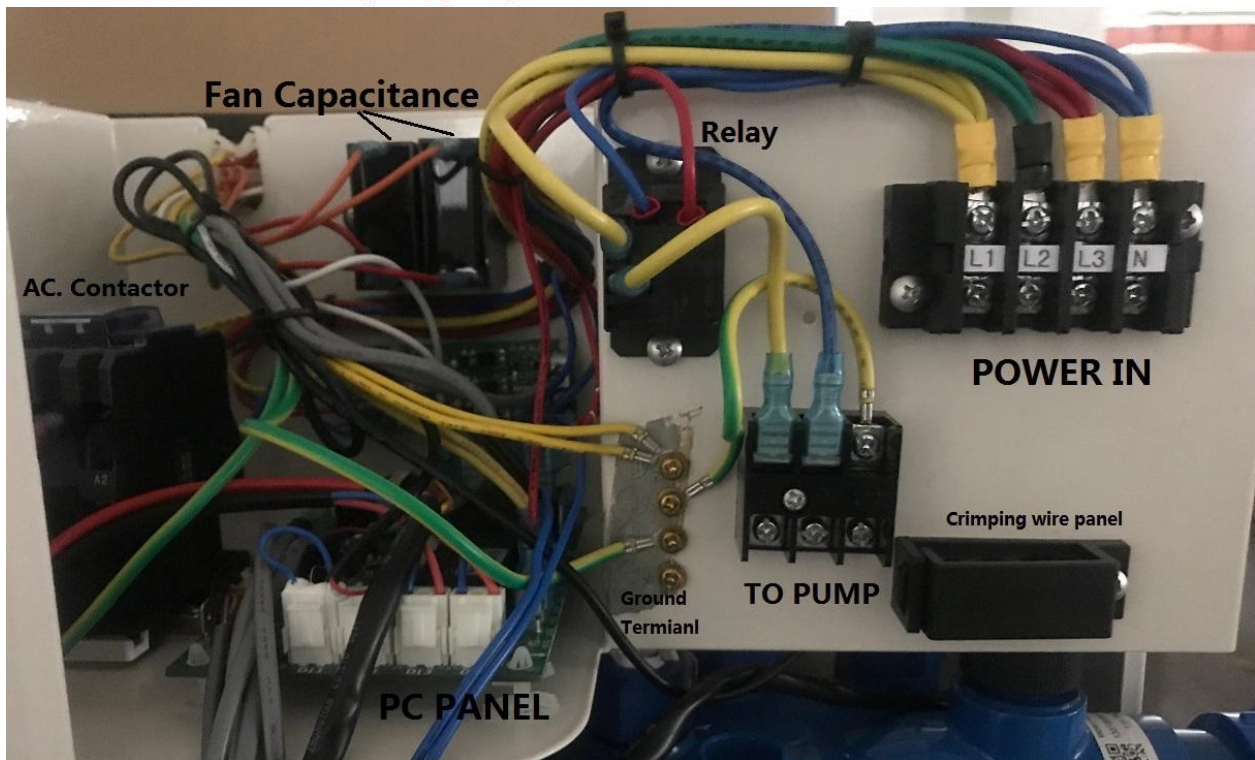
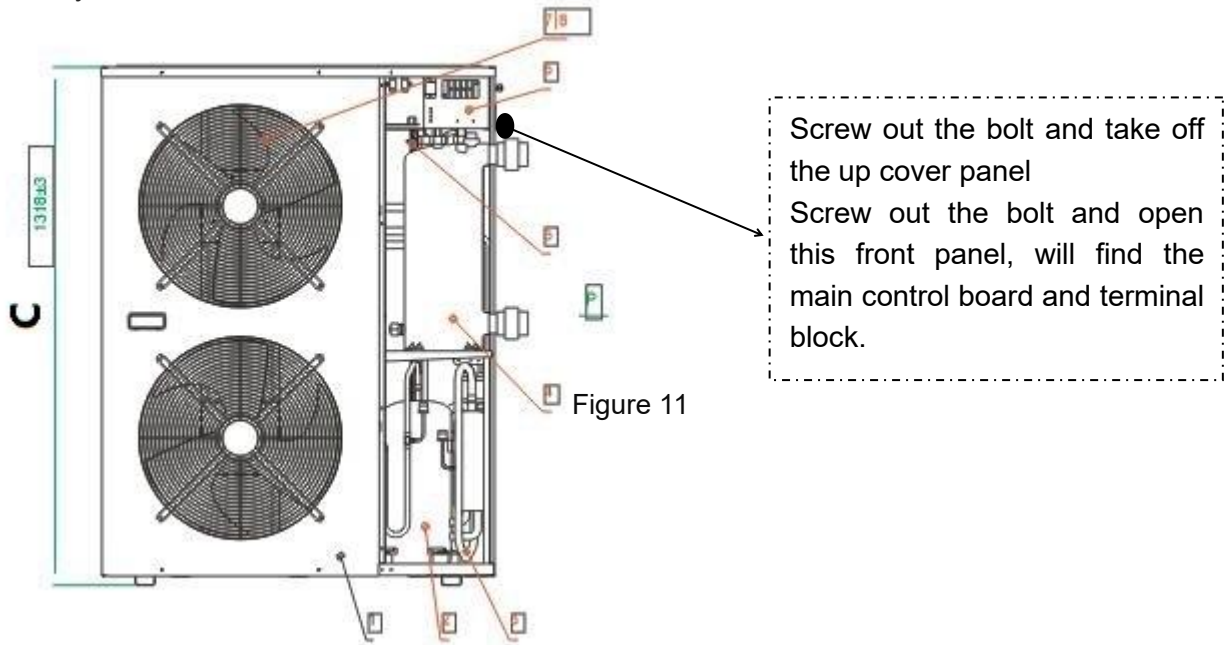

Figure 12 Electrical Box

7.2 Electrical Wiring Specification

Model	Electrical Wiring Specification
YC-025TA1	2*2.5 mm ² +1*1mm ²
Terminal	The terminal can connect the wire max. is 4 mm ²

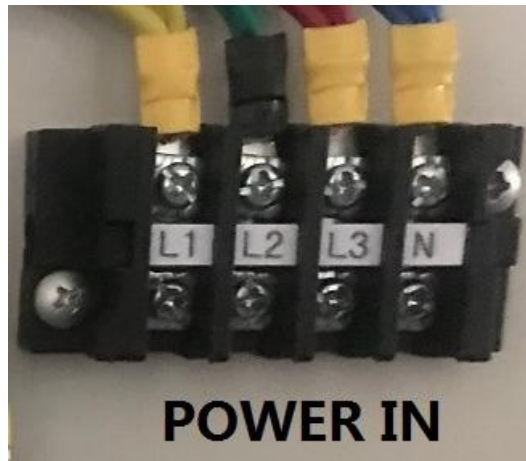
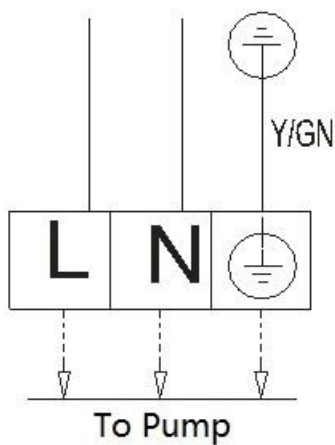

Figure 14

7.3 Circulation pump installation

The heat pump provide power to the pump as the follow drawing.



NOTE:
 If the pump power less than 150w,
 please connect the pump wire refer
 to the left drawing

Figure 15

Connect as this wire when the pump power more than 150w

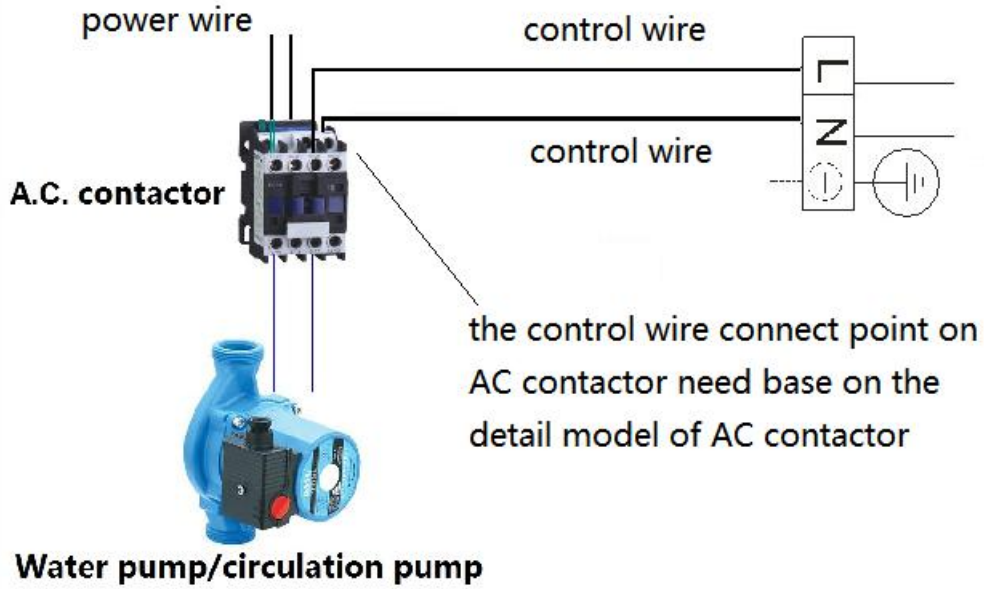

Figure 16

7.4 Electric wiring diagram

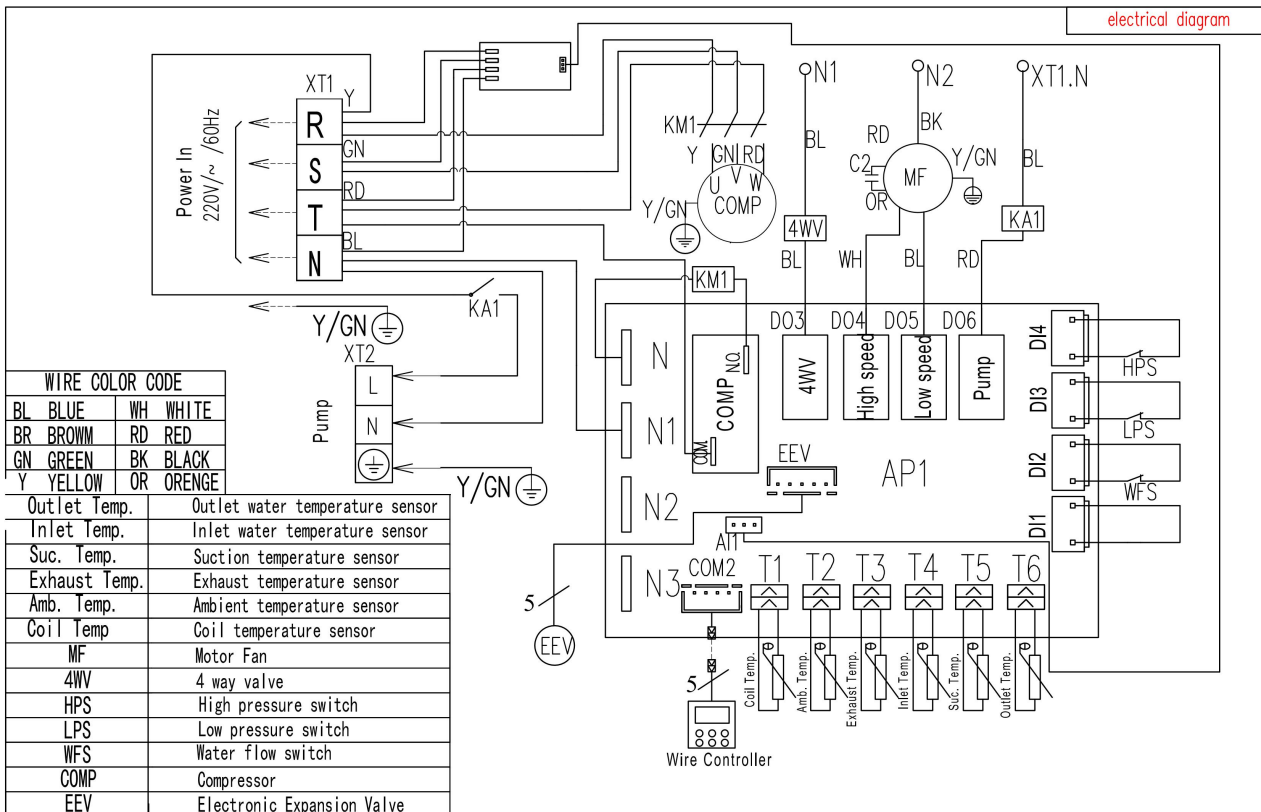

Figure 17

7.5 Main Control Board Interface

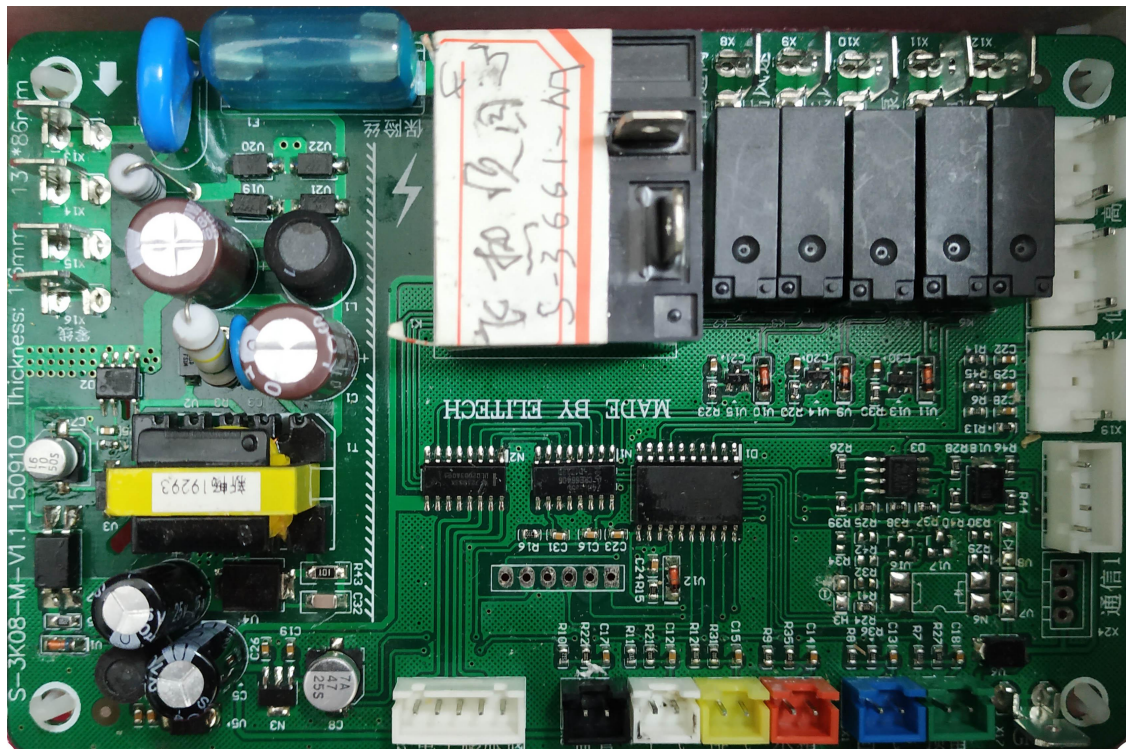

Figure 18

8. Instruction of operation

8.1 Control system specifications

8.1.1 Operating condition

- Voltage: 220V \sim \pm 10%,50Hz \pm 1Hz.
- Ambient temperature: -15 \sim +43 $^{\circ}$ C
- Storage temperature: -20 \sim +75 $^{\circ}$ C
- Relative humidity: 0 \sim 95%RH
- Temperature accuracy: \pm 1 $^{\circ}$ C

8.1.2 Main function

- Three operation mode: heating,cooling and constant temperature mode.
- Display the pool temperature and setting temperature, and also can query the coil temperature, ambient temperature and exhaust temperature and so on.
- Power cut memory function.































- When power cut, the clock will still work.
- Timing on/off.
- Automatic defrosting.
- Forced to defrost.
- Large LCD display.
- Has perfect protection function.
- The error code display and query
- Key-Lock Function
- Anti-freezing function
- When there is no wire controller or wire controller is broken, the system can recognize it, and control the heat pump to run automatically.



8.2 Wire controller and operation









8.2.1 Controller Instruction













symbol	status	meaning
	Constantly bright	heat pump is on
	Extinguished	Heat pump is off
	Constantly bright	at cooling mode

	Constantly bright	at heating mode
	Constantly bright	need repair
	Constantly bright	at AUTO mode
	Extinguished	Currently in the manual set temperature state
	Constantly bright	this unit is a water connection heat pump
	Extinguished	this unit is a refrigerant connection heat pump
	Constantly bright	heat pump is on and at defrosting
	Flashing	Heat pump is on and at defrost delay
	Flashing	heat pump is off and at refrigerant recovery status
	Constantly bright	electric heater is on for quick heating
	Flashing	electric heater is on for disinfection
	Constantly bright	current water temperature in the tank
	Constantly bright	set water temperature in the tank
	Constantly bright	current outlet water temperature
	Constantly bright	current inlet water temperature
	display	Display actual water temperature, set water temperature and fault code
	Constantly bright	Currently showing Celsius temperature
	display	Show real time
	display	Timer function is on
	display	Currently in the on-time working hours
	Flashing	set start time for working time
	display	Currently at boot time, non-working time
	Flashing	end time of current set working time
1	Constantly bright / Extinguished	Timing working period 1,always on when set, at other conditions are off.
2	Constantly bright / Extinguished	Timing working period 2,always on when set, at other conditions are off.
3	Constantly bright / Extinguished	Timing working period 3,always on when set, at other conditions are off.
	Constantly bright	start timing water return function
	Flashing	start manual water return function
	Extinguished	turn off water return (timing/manual) function
	display	Currently the return water is in regular timing working period
	Flashing	Current set start time of backwater working time
	display	Currently the return water is in the non-working hours
	Flashing	Currently set end time of water return period
1	Constantly bright / Extinguished	Timing zero cold water period 1, always on when setting, at other conditions are off.

2	Constantly bright / Extinguished	Timing zero cold water period 2, always on when setting, at other conditions are off.
	Constantly bright	The button is locked
	Constantly bright	The controller is connected to the router



8.2.2 Instruction of the buttons

	button		instruction
1	Power/exit button		<ol style="list-style-type: none"> 1. Press and hold for 1 second to turn on/off. 2. In the query state, click this button to return to the main interface.
2	up		<ol style="list-style-type: none"> 1. Press at main interface to set the temperature. 2. Press and hold for 3 seconds in the power on/off state to enter the query state. 3. In the query status, press and check status 4. At parameter set status, press to modify parameters
3	down		<ol style="list-style-type: none"> 1. Press at main interface to set the temperature. 2. Press and hold for 3 seconds in the power on/off state to enter the query state. 3. In the query status, click to status query 4. Under parameter setting state, click parameter to modify
4	Mode button		<ol style="list-style-type: none"> 1. In the main interface, press and hold for 3 seconds to start (and enter zero cold water time setting) / turn off the timing zero cold water function; (when parameter 64=1) 2. In the main interface, short press for more than 1 second to cancel the zero cold water function in this period; (when parameter 64=1) 3. In the main interface, short press within 1 second to activate/deactivate the manual zero cold water function. (when parameter 64=1) 4. Under the main interface, click to switch between heating and cooling operation status (when parameter 64=0)
5	time		<ol style="list-style-type: none"> 1. In the main interface, press to enter the clock setting, and press to switch time "hour" and "minute". 2. In the main interface, press and hold for 3 seconds to start (and enter the timing time setting) / turn off the timing mode.
6	set		<ol style="list-style-type: none"> 1. Under the main interface, press to switch between automatic/manual temperature control mode. "AUTO" is displayed in the automatic mode and is not displayed when manual 2. In the main interface, press and hold for 3 seconds to enter the parameter interface.

7	Button combination	 + 	at main interface when ON, press and hold for 3 seconds to turn on/off quick heating
		 + 	at main interface when ON, press and hold for 3 seconds to turn on/off defrosting
		 + 	Within 5 minutes after power-on, at the main interface of shutdown, press and hold for 10 seconds to enter/exit refrigerant charging or recycling mode
		 +  + 	Under the main interface, press and hold for 10 seconds to turn on/off the “sterilization” function manually (Parameter 66=1 is valid)
		 +  +  + 	Within 5 minutes after power-on, press and hold for 5 seconds to restore the factory parameter settings.

8.2.3 Operation Instruction

1) Turn ON/OFF the heat pump

When the controller is in the normal display state, press “” button for more than 1 second to switch the controller to the power on or off state. When heat pump is ON, “” lights up and is normally controlled. When heat pump is off, “” does not light up and the controller stops controlling output. The controller can display and operate normally in the power on state and off state. When the controller is powered on for the first time, it is in the off state. Then from the 2nd time, the state will be same as last time before power off.

2) Set the temperature control mode:

When the controller is in normal display state, press the “M” key to switch between manual temperature control mode and automatic temperature control mode;

The “AUTO” symbol lights up in the automatic temperature control mode, And the “AUTO” symbol does not light up in the manual temperature control mode;

In the manual mode, the heating/cooling water temperature is controlled according to the manual temperature setting value;

In the automatic mode, the hot water temperature is automatically adjusted according to the ambient temperature for control;

3)Set the water temperature:

In manual mode, press“^” or “v” key to enter the water temperature setting state. Then starts to display the setting symbol and display the corresponding water temperature set according to the current cooling or heating mode. When the water temperature is set, press the “^” or “v” button to increase or decrease the water temperature setting value; Press and hold the “^” or “v” button for more than 1 second to quickly increase or decrease the water temperature setting. Press and release the “⏻” button immediately or no button operation in 5 seconds, controller will exits the modification and return to the normal display state. When the parameter value is modified, it will flash for 2 seconds and then return to the normal display state.

In the automatic mode, press the “^” or “v” key to enter the automatic temperature adjustable parameter deviation setting state. Then start to display the setting symbol and display the corresponding deviation setting value. Press “^” or “v” to increase or decrease the deviation setting value; press “^” or “v” for more than 1 second to quickly adjust or decrease the deviation setting value; press and Immediately release the “⏻” button or no button operation in 5 seconds to exit the modification and return to the normal display state. When the parameter value is modified, it flashes for 2 seconds and then returns to the normal display state.

4)Real time clock settings:

In the main interface, click the “🕒” button to enter the real-time clock setting interface; In the real-time clock interface, press the “🕒” button, the hour part of the number flashes, press “^” or “v”, you can Set the hour of the clock; when the hour part is set, press the “Time” button again, the number of minutes will flash, press “^” or “v” to set the minute of the real time clock; After the minute part is set, press the “🕒” button again to confirm the real-time clock setting and return to the main interface;

In the real-time clock setting interface, if there is no button operation for 5 seconds, the current real-time clock setting value is confirmed, and the main interface is returned;

In the real-time clock setting interface, press the “⏻” button to confirm the current real-time clock setting value and return to the main interface.

5)Timing work settings:

Press and hold the “🕒” button for 3 seconds in the main interface to enable or disable the timed working mode. When the timed working mode is enabled, enter the timed period setting. Press and release “🕒” to switch the hour and minute of the start time and end time of the three time slots in sequence., The value is flashing when switching to the corresponding value of the certain time slot. At the same time, “ON” or “OFF” symbol flashes, Press “^” or “v” to increase or decrease the corresponding value. After setting the timed period, press and immediately releasing the “switch” button or no button operation in 15 seconds, the changes can be saved and returned to the normal display state.

When the timing control mode is enabled, the corresponding symbols are displayed in the working

period (ON) and the non-working period (OFF) respectively. In the power-on state, heating/cooling is performed only during the set working period, and the rest of the time is not heating/cooling. When the start time and end time of a certain working period are the same, it is regarded as canceling the timing period. When all timed periods are cancelled, it is considered to be in working hours throughout the day. If the start time of a certain working period is greater than the end time, the end time is considered to be the next day. The three time periods default to 05:00~07:00, 16:00~18:00, 20:00~00:00.

6)Set the cooling/heating mode:

With the controller in normal display, press “” to switch between cooling or heating mode. When switching to the cooling or heating mode, the cooling or heating symbol flashes quickly for 3 seconds and then returns to the normal display state. When switching to the cooling mode, the temperature judgment automatically selects “manual mode”, and the water temperature can be set at this time. When the cooling/heating mode is switched, the compressor is allowed to start running after at least 3 minutes of stopping.

7) Forced speed heating:

When following conditions are met at the same time: the controller is in the normal display state and heat pump is in the power-on state.

Heat pump needs to be in the working period after the timing control is enabled.

The current heating mode is met and the temperature condition for continuing heating is satisfied, No other alarms that do not allow "speed heating" occur.

Press“M” + “^” button at the same time for more than 5 seconds, the “speed hot” function can be activated or deactivated. When the “speed heat” is running, the symbol lights up. If the heat pump is in cooling mode, “speed heat”is not allowed.

8) Forced defrosting:

When following conditions are met at the same time: the controller is in the normal display state and heat pump is in the power-on state.

Heat pump needs to be in the working period after the timing control is enabled.

The current heating mode is set and the set defrosting time is not zero and the temperature condition of the defrosting is continued, No other alarms that do not allow "frost" occur.



Press“M” + “v” button at the same time for more than 5 seconds to activate or deactivate the "Defrost" function. The symbol is illuminated when the "Defrost" is running. If heat pump is in cooling mode, "defrosting" operation is not allowed.

9)Forced sterilization:

If the controller is in the normal display state and it is currently in the heating mode, press the “M”+“^”+“v” button at the same time for more than 5 seconds to activate or deactivate the

“sterilization” function. The  flashes at this manual “sterilization” operation. When heat pump is in cooling mode, "sterilization" operation is not allowed.

10) Return time setting: (Fluorine cycle unit is valid; parameter 64=1)

Press and hold the “” button for 3 seconds in the main interface to enable or cancel the timed water return mode. When the timed water return mode is enabled, the timed return time setting is entered. Press “” to switch the start time of the two time slots in turn, the hour part, the minute part, the hour part of the end time. The corresponding parts are flashed when the corresponding value is switched. The corresponding time period is displayed and the “ON” or “OFF” symbol is flashing. Press “^” or “v” to up or down and flashing to display the corresponding value. After setting the timed period, press and immediately release the “” button or no button operation in 15 seconds, the changes can be saved and returned to the normal display state.

When the timing control mode is enabled, the corresponding symbols are displayed separately during the working period and the non-working period. In the power-on state, the water is automatically returned only during the set working period, and the remaining time is not returned. When the start time and end time of a certain working period are the same, it is regarded as canceling the timing period. When all timed periods are cancelled, it is considered to be in an untimed return time period throughout the day. If the start time of a certain working period is greater than the end time, the end time is considered to be the next day. The factory default return water time is as follows:

- A, time period 1 opening time: 6:30
- B, time period 1 closing time: 7:30
- C, time period 2 opening time: 18:30
- D, time 2 closed time: 22:30

11) Query running status:

When the main interface of the power on or off is displayed, press and hold the “^” or “v” button for more than 3 seconds to enter the running status query interface; press and immediately release the “^” or “v” button to check each operating condition; press and immediately release the “” button or automatically return to the normal display state without any button operation in 30 seconds.

After entering the view mode, the last viewed data code (the default is “00” after power-on) and its corresponding value are displayed. After each press and immediately release the “v” button, the following table can be displayed in order:

name	code	remark
Fluorine cycle/water cycle heat pump	00	0=water cycle; 1=fluorine cycle
High pressure switch	01	0=disconnect; 1=close
Low pressure switch	02	0=disconnect; 1=close
Water flow switch	03	0=disconnect; 1=close
EEV value	04	Measured value
Evaporator coil sensor	05	Measured value

ambient temperature sensor	06	Measured value
absorption temperature sensor	07	Measured value
exhaust temperature sensor	08	Measured value
inlet water temperature(tank water temperature)	09	Display value = measured value + compensation value
outlet water temperature(return water temperature)	10	Display value = measured value + compensation value
compressor	11	0=stop; 1=running
4-way valve	12	0=stop; 1=running
high-speed fan	13	0=stop; 1=running
low-speed fan	14	0=stop; 1=running
circulation water pump	15	0=stop; 1=running
electric heater	16	0=stop; 1=running

12)Key lock:

When the controller is in the normal display state, the button is locked when there is no button operation for more than 60 seconds. Press any button at this time to unlock.

8.2.4 Control Output

1) Water temperature control

Normal water temperature control can be performed when the controller is turned on.

Heating mode:

When the water tank (inlet water) temperature \leq set temperature –return difference, heating begins;

When the water tank (inlet water) temperature \geq the set temperature, the heating is stopped;

Cooling mode:

When the water tank (inlet water) temperature \geq set temperature + return difference, the cooling starts;

When the water tank (inlet water) temperature \leq the set temperature, the cooling stops.

2) Electric heater control:

At heating mode, when the water tank temperature \leq set temperature -20 °C, electric heater starts,

and the symbol  lights up;

When the water tank temperature \geq the set temperature, the electric heater is turned off and the symbol is extinguished.

3) Circulating pump control (water circulation heat pump):

When defrosting, water pump is forced to run.

When cooling or heating, it is turned on 10 seconds before the compressor and stops 30 seconds after the compressor.

Antifreeze mode:

When the controller is powered on, whether heat pump is off or on, when the ambient temperature is

too low, water pump will enter antifreeze mode to prevent the circulation line or the water tank from freezing. The specific conditions for enabling and disabling the environment for low temperature antifreeze are as follows:

- a. When the ambient temperature is $\leq 2^{\circ}\text{C}$, and the duration of the circulating water pump is off for more than 30 minutes, the circulating water pump is forcibly started for 60 seconds;
- b. Exit the antifreeze mode when the ambient temperature rises to $\geq 4^{\circ}\text{C}$.
- c. When the ambient temperature sensor is faulty, it is mandatory to start the circulating water pump periodically, and run for 60 seconds every 30 minutes.



4) Circulation pump control (optional: fluorine cycle heat pump)

a. Manual water circulation

When the controller is in the normal display state, click the "" button to start the manual water circulation function. At this time, the "Back Pump" icon flashes.



The manual return water control is as follows:

- No pipe temperature sensor

When the manual return water function is activated, the water pump is started. After 30 seconds, the buzzer sounds three times, prompting the user to use the hot water; after 30 seconds, the "" icon flashes 3 times and the buzzer sounds for 3 seconds. Turn off the water pump and the "" icon goes out (if the timed water is set before, the "Back Pump" and "Timer" icons are displayed).



During this process, press and hold the "cold and hot" button for 1 second to manually cancel the manual water return function.

- There is a pipe temperature sensor

When the manual return water function is activated, if the return water pipe temperature is $< 35^{\circ}\text{C}$ (default 35°C), and the current water tank temperature \geq return water set temperature + return water temperature difference, return water pump will starts. If the return water pipe temperature \geq back water set temperature + return water temperature difference for 5 seconds or temperature control return water time \geq 2 minutes, the buzzer sounds three times, prompting the user to use hot water; after 30 seconds, the "" icon flashes 3 times, buzzing the device will beep for 3 seconds, the water pump will be turned off, and the "" icon will be off (if the timed water is previously set, the "Back Pump" and "Timer" icons will be displayed).

During this process, press and hold the "cold and hot" button for 1 second to manually cancel the manual water return function.

b. Timed return water:

When the controller is in the normal display state, press and hold the "" button for 3 seconds to start or turn off the timed water return function; the "" icon lights up when it is turned on, and the "" icon turns off when it is turned off.

The timing return control is as follows:

A, no return water temperature sensor

When the timing water returned function is activated and the timed start time is reached, the water pump is started. After 30 seconds, the water pump is turned off, and the buzzer sounds three times, prompting the user to use the hot water; After 15 minutes, the water pump is started again and the

cycle is repeated. .

If press and hold the "cold hot" button for 1 second or the timed return water close time is reached in this process, the timed water return function will be turned off (the return water function is still valid for next time, unless the timed return function is turned off).

B, there is a return water temperature sensor

When the timing return water starts, and the start time reaches, if the return water pipe temperature < return water set temperature, and the current water tank temperature \geq return water set temperature + return water temperature difference, the return water pump will start. If backwater pipe temperature \geq return water set temperature + return water temperature difference for 5 seconds or temperature control return water time \geq 2 minutes, the water pump will turn off. The buzzer sounds three times, prompting the user to use hot water; When the pipe temperature < return water set temperature, the water return pump is started again and the cycle is repeated.

If press and hold the "cold hot" button for 1 second or the timed return water close time is reached in this process, the timed return function will be turned off (the return water function is still valid for next time, unless the timed return function is turned off).

Note: When the return water temperature is faulty, it will automatically switch to the "no return water temperature sensor" mode.

5) Anti-fouling function

Sometimes the return pump/circulation pump stops for a long time, the pump will be rusted or scaled, and the pump needs to be started periodically.

After the pump has been on standby for 12 hours, it is forced to run for 1 minute.

6) High temperature sterilization control for Electric heater

Manual sterilization mode:

While the controller is in normal display state, press and hold the "M"+"^"+"V" button for more than 5 seconds at the same time, the heater symbol flashes to indicate that it enters the manual sterilization mode. At this time, the electric heater is started to heat the water to 75°C, And the water temperature is maintained at 70 to 75°C for 30 minutes, then the sterilization mode will be automatically exited.

After starting the manual sterilization function, press and hold the "M" + "^" + "V" button for 5 seconds or more at the same time to exit the manual sterilization mode.

When the water temperature setting value is $\geq 75^\circ\text{C}$, the sterilization function is not activated.

Automatic sterilization mode:

If the water temperature setting value is $< 75^\circ\text{C}$, the controller operation time reaches 7 days, the controller enters the automatic sterilization mode. Once the automatic sterilization mode exits, time begins from zero.

When the ambient temperature is $\geq 20^\circ\text{C}$, the electric heater is started at 1:00 am to start sterilization;

When the ambient temperature is $< 20^\circ\text{C}$, the electric heater is started at 15:00 pm to start sterilization;

After the automatic sterilization function is activated, the sterilization symbol flashes. At this time, the electric heater is started to heat the water to 75°C. And the water temperature is maintained at 70 to 75°C for 30 minutes, then the sterilization mode will be automatically exited.

When the water temperature setting value is $\geq 75^\circ\text{C}$, the sterilization function is not activated.

8.2.5 The Alarm

1) Low pressure fault:

After the compressor running for 5 minutes, if the low pressure switch is detected to be in the off state for 10 consecutive seconds, the compressor immediately stops running. At this time, the controller displays the low pressure fault alarm code "04E". If the low pressure switch is restored, error code does not occur. If no other protection or locking occurs, the compressor is restarted after 3 minutes.

If low pressure fault protection appears 3 times within 1 hour, the controller will lock the protection. And the compressor will lock in the shutdown protection state. At this time, only the shutdown and restarting can unlock the compressor. The low pressure switch is not detected during the defrosting.

2) High pressure failure:

After the compressor is started, if the high pressure switch is detected to be in the off state for 10 seconds, the compressor immediately stops running. At this time, the controller displays the high pressure fault alarm code "03E". If the high pressure switch is restored, error code will not occur. And if no other protection or locking occurs, the compressor is restarted after 3 minutes.

If high pressure fault protection appears 3 times within 1 hour, the controller will lock the protection, and the compressor will be locked in the shutdown protection state. At this time, only the shutdown and restarting can unlock the compressor.

3) High exhaust temperature failure:

After the compressor starts running for 1 minute, when the exhaust gas temperature is detected to be higher than or equal to the exhaust high temperature protection value by 110°C for 10 consecutive seconds, an high exhaust temperature alarm occurs and the compressor stops. At this time, controller shows high temperature fault alarm code "02E". When the exhaust temperature drops back to 90°C, the alarm is released and the normal temperature control function is restored.

If high temperature fault protection appears 3 times within half an hour, the controller will lock the protection. And the compressor will be locked in the shutdown protection state. At this time, only the shutdown and restarting can unlock the compressor.

4) Water flow failure (water cycle model):

After the circulating water pump starts, it detects that the water flow switch is in the off state for 10 seconds, then heat pump stops. At this time, the controller displays the water flow switch fault alarm code "01E". Periodically (1 minute) restarts the water pump and 10 seconds later, the flow switch is detected. If water flow switch is closed, heat pump will goes to normal running. If the fault occurs 3 times within 1 hour, the fault is locked and heat pump will not starts.

5) antifreeze protection (water cycle model):

When the controller is powered on, when the ambient temperature too low, it will enter the antifreeze mode to prevent the circulation line or the water tank from freezing.

When the ambient temperature is $\leq 2^{\circ}\text{C}$, heat pump enters the first-class antifreeze. When the circulating water pump continuously stops for more than 30 minutes, it starts for 60 seconds, then repeats the cycle.

When the ambient temperature is $\leq 2^{\circ}\text{C}$, and the water tank temperature is $\leq 5^{\circ}\text{C}$, heat pump enters the secondary anti-freeze protection, Heat pump automatically turned on for heating. When the ambient temperature $\geq 4^{\circ}\text{C}$ or the tank temperature $\geq 15^{\circ}\text{C}$, heat pump stops heating and exits the

secondary frost protection

6) Low ambient temperature protection:

When the ambient temperature is $\leq -9\text{ }^{\circ}\text{C}$, the compressor is prohibited from running. When the ambient temperature is $\geq -7\text{ }^{\circ}\text{C}$, normal operation is resumed, This protection has no fault display.

7) Water temperature too low protection at cooling mode(water cycle heat pump)

In the cooling mode with compressor running for 5 minutes, if detects that the outlet water temperature is $<5\text{ }^{\circ}\text{C}$ for continuous 5 seconds, heat pump enters subcooling protection. The compressor and the fan stop running, And the water pump operates normally. When the outlet water temperature is detected to be $\geq 7\text{ }^{\circ}\text{C}$, heat pump exits the subcooling protection and enters normal operation.

8) Water temperature too high protection at heating mode (water cycle heat pump)

In the heating mode, after compressor running for 5 minutes, if the water temperature is detected by continuous 5S $\geq 65\text{ }^{\circ}\text{C}$, it is judged that the outlet water temperature is too high. It will shutdown heat pump for protection and when the outlet water temperature is detected to be $\leq 60\text{ }^{\circ}\text{C}$, the protection is withdrawn.

9) Temperature sensor failure:

Heat pump will stop once the water tank temperature sensor or outlet water temperature sensor or ambient temperature sensor is faulty.

When absorb or exhaust or evaporator coil or water return temperature sensor is faulty, electric heater is allowed to operate.

When the return water temperature sensor fails, the return pump is allowed to run (do not judge the return water temperature)

When the water tank or ambient temperature sensor are faulty, electric heating operation is not allowed.

"11E", "12E", "13E", "14E", "15E", "17E", "18E", "19E". are correspondingly displayed when the coil temperature sensor, ambient temperature sensor, exhaust temperature sensor, inlet water temperature sensor/tank temperature sensor, absorb temperature sensor, and outlet water temperature sensor/return water temperature sensor are faulty.

10) Other:

"09E" is displayed when the communication between the main control board and the wire controller is abnormal or the data line is not connected normally. "--:--" is displayed when the valid clock cannot be obtained. And the communication indicator of the main control board flashes. The buzzer sounds when an alarm occurs. Press any key to silence the alarm.

The fault code table is as follows:

Error code	name
01E	Water flow switch disconnected(water cycle heat pump)
02E	Exhaust temperature too high
03E	High pressure switch failure
04E	Low pressure switch failure
09E	Communication failure

11E	Evaporator coil temperature sensor failure
12E	Ambient temperature sensor failure
13E	Exhaust temperature sensor failure
14E	Water inlet temperature sensor failure
15E	Tank temperature sensor failure
16E	
17E	Absorb temperature sensor failure
18E	Water outlet temperature sensor failure
19E	Return water temperature sensor failure
20E	Outlet water temperature too high protection(water cycle heat pump)
21E	Outlet water temperature too low protection(water cycle heat pump)

9. Adjusting and Initial operation

9.1 Attention

- Within 12 hours after running, please connect the circuit breaker, and make the crankcase heater be pre-heated.
- Open the valve of water system, and the valve of assistant tank, inject water into the system, and exhaust air inside.
- Do adjustment after electrical safety inspection.
- After the power is switched on, start the test running of heat pump, to see if it can function well.
- Forced operation is forbidden, because it is very dangerous to work without protector.

9.2 Preparation Before Adjustment

- The system is installed correctly.
- Tubes and lines are putted in the right place.
- Accessories are installed.
- Ensure the smooth drainage.
- Ensure the perfect insulation.
- Correct connection of ground lead.
- The supply voltage can meet the requirement of rated voltage.
- Air inlet and outlet function can work well.
- Electrical leakage protector can work well.

9.3 Adjustment Process

- Check if the switch of the line controller can work well.

-
- Check if the function keys of the line controller can work well.
 - Check if the indicator light can work well.
 - Check if the drainage system can work well.
 - Check if the system can work well after starting up.
 - Check if the water outlet temperature is acceptable.
 - Check if there is vibration or abnormal sound when the system is functioning.
 - Check if the wind, noise and condensate water produced by the system affect the environment around.
 - Check if there is refrigerant leakage.
 - If any fault occurs, please check the instructions first, to analyze and remove the fault.

10. Operation and maintenance

10.1 Personals shall possess professional knowledge or operate according to professionals from our company. To ensure the well functioning, the system shall be checked and maintained after a period of time. During the maintenance, please pay attention to some points below:

- Control and protect the equipment, please do not adjust any settings discretely.
- Pay close attention to whether all the operation parameters is normal during system working.
- Examine regularly whether the electrical connection is loose, if yes, fasten it on time.
- Examine regularly the reliability of the electrical components, change all the failed or unreliable components on time.
- There will be calcium oxidized or other mineral substance deposition on the surface of water heat ex-changer copper coil after long period of operation, which will influence the heat exchange performance and lead to high electrical consumption, discharge pressure increasing and air suction pressure drop, unit hot water volume produced is less. We can adopt formic acid, citric acid, acetic acid or other organic acid to clean.
- The dirt retention on the surface of evaporator fin should be blowed by more than 0.6Mpa compressor air, brushed by fine copper wire, or flushed by high pressurized water, usually one time per month; if too much dirt, we can use paintbrush dipping gasoline to clean.
- After long downtime, if we restart the equipment, we should make following preparations: examine and clean the equipment carefully, clean the water pipeline system, examine the water pump, and fasten all the wire connections.
- Replacement parts must use our company original accessories, can not be replaced by other similar accessories.

10.2 Refrigerant filling

Examine the refrigerant filling condition through reading the data of liquid level from display screen, also the air suction and exhaust pressure. If there is leakage or changing components of the refrigeration circulation system, we have to make air tightness examination first.

10.3 Leak detection and air tightness experiment:

During leak detection and air tightness experiment, never let the refrigeration system filling oxygen, ethane or other flammable harmful gas, we can only adopt compressed air, fluoride or refrigerant for such experiment.

10.4 To remove the compressor, please follow the following steps

- Turn off the power supply
- Exhaust the refrigerant from the low pressure end, attention to reduce the exhaust speed, and avoid frozen oil leakage.
- Remove the compressor air suction and exhausting pipe.
- Remove the compressor power cables.
- Remove the compressor fixing screws.
- Remove the compressor.

10.5 Conduct regular maintenance according to the user manual instruction, to make sure the unit running in good condition.

- Fire prevention: if there is a fire, please turn off the power switch immediately, put the fire out with fire extinguisher.
- To prevent flammable gas: the unit working environment should stay away from gasoline, ethyl alcohol and other flammable materials, to avoid explosion accident.
- Malfunction: if malfunction occurs, should find out the reason, eliminate it and then reboot the unit. Never boot the unit forcibly if the malfunction has not been eliminated. If refrigerant leakage or frozen liquid leakage, please turn off all the power switch, if the unit can not stop buy controlling switch, please turn off the general power switch.
- Never short connect the wire for protection required device, or else, in case unit malfunction, it can not be protected normally and will damage the unit.

11. Fault analysis and elimination method

Fault	Possible cause	Detection and elimination method
Discharge pressure is too high.	<ul style="list-style-type: none"> ◆ There is air or other non-condensable gas existed in the system. ◆ Water heat exchanger is scaling or fouling blockage. ◆ The circulation water volume is not enough. ◆ Refrigerant charging is too much. 	<ul style="list-style-type: none"> ● Vent the air from water heat exchanger ● Wash and clean the water heat exchanger ● Examine the water system pipeline and pump. ● Drain part of the refrigerant
Discharge pressure is too low.	<ul style="list-style-type: none"> ◆ Liquid refrigerant flow through evaporator to compressor, which make foam for the frozen oil ◆ Suction pressure is too low ◆ Refrigerant charging is too less, the refrigerant air goes into liquid pipeline 	<ul style="list-style-type: none"> ● Examine and adjust the expansion valve, make sure the expansion valve temperature sensor bulb is close connected with the air suction pipe, and absolutely insulated with the ambient environment. ● Please refer to "Fluorine filling if suction pressure too low"
Suction pressure is too high.	<ul style="list-style-type: none"> ◆ Discharge pressure is too high. ◆ Refrigerant charging is too much. ◆ Liquid refrigerant flow through evaporator to compressor. 	<ul style="list-style-type: none"> ● Drain part of the refrigerant. ● Examine and adjust the expansion valve, make sure the expansion valve temperature sensor bulb is close connected with the air suction pipe, and absolutely insulated with the ambient environment.
Suction pressure is too low.	<ul style="list-style-type: none"> ◆ Ambient temperature is too low. ◆ The evaporator liquid inlet or compressor suction pipe is blocked, expansion valve unadjusted, or failed. ◆ The refrigerant is not enough in the system. 	<ul style="list-style-type: none"> ● Adjust suitable overheat temperature, examine whether there is Fluorine leakage from the expansion valve temperature sensor bulb. ● Examine Fluorine leakage. ● Examine the installation condition.
Compressor stopped because of high pressure protection.	<ul style="list-style-type: none"> ◆ The water inlet temperature is too high, circulation water is not enough. ◆ The high pressure stop setting is not correct, the air suction overheat greatly. ◆ Fluorine filling is too much. 	<ul style="list-style-type: none"> ● Examine water system pipeline and water pump. ● Examine the high pressure switch. ● Examine the Fluorine filling volume, drain part of refrigerant.
Compressor stopped because of motor overloading.	<ul style="list-style-type: none"> ◆ The voltage is too high or too low. ◆ Discharge pressure is too high or too low. ◆ Device loading failure. ◆ Ambient temperature is too high. ◆ Motor or connecting terminal is in short circuit. 	<ul style="list-style-type: none"> ● The voltage should be controlled within more or less 20V than rated voltage, and phase difference within $\pm 30\%$. ● Examine the compressor current, compare with the full loading current indicated in the user manual. ● Improve air ventilation.
Compressor stopped because of built-in thermostat.	<ul style="list-style-type: none"> ◆ The voltage is too high or too low. ◆ Discharge pressure is too high. ◆ The refrigerant in the system is not enough. 	<ul style="list-style-type: none"> ● Examine the voltage to make sure it is within the specialized range. ● Examine the discharge pressure and find out the reason. ● Examine whether there is Fluorine leakage.
Compressor stopped because of low voltage production	<ul style="list-style-type: none"> ◆ Dry filter clogging. ◆ Expansion valve failure. ◆ The refrigerant is not enough. 	<ul style="list-style-type: none"> ● Examine, maintain, or change dry filter. ● Adjust or change expansion valve. ● Fill in refrigerant.
High noise of compressor	<ul style="list-style-type: none"> ◆ There is liquid hammer for liquid refrigerant flowing through evaporator to compressor. 	<ul style="list-style-type: none"> ● Adjust liquid supply, examine whether normal for the expansion valve and air suction over heat degree.
Compressor can not start.	<ul style="list-style-type: none"> ◆ Over current relay is tripped, insurance is burn. ◆ The control circuit is not connected. ◆ No current. ◆ The pressure is too low, which can not conduct the pressure switch. ◆ The contactor coil is burn out. ◆ Water system failure, relay is tripped. 	<ul style="list-style-type: none"> ● Set the control circuit in manul mode, restart the compressor after maintenance. ● Examine controlling system. ● Examine power supply. ● Examine whether the refrigerant is too less. ● Reconnect, adjust two of the wiring.

12. Technical parameter

Model No.	YC-025TA1
Power Supply	380-415V/3/50Hz
Heating Capacity(kW) ¹	27.2
Power Input(kW) ¹	4.06
COP ¹	6.70
Heating Capacity(kW) ²	20.52
Power Input(kW) ²	4.26
COP ²	4.82
Heating Capacity(kW) ³	16.94
Power Input(kW) ³	4.34
COP ³	3.90
Max Power Input(kW)	6.58
Max Current(A)	11.8
Refrigerant Type	R410A
Refrigerant Weight	3500g
Heat Exchanger	Titanium alloy heat ex-changer
Expansion Valve	Electronic Expansion Valve
Air Flow Direction	Horizontal Type
Water Flow Volume(m ³ /h)	10.0
Net Dimensions(L*W*H)(mm)	1086×420×1318
Package Dimensions(L*W*H)(mm)	1196×560×1480
Working temperature range (°C)	-15~43
Noise(dB)	54
Net Weight (kg)	135
Gross Weight (kg)	153
Water connection(mm)	50

Testing condition: ¹ Heating Capacity at Air temp. 27 °C / 24 °C, Water in/out temp. 27 °C / 29 °C
² Heating Capacity at Air temp. 15 °C / 12 °C, Water in/out temp. 26 °C / 28 °C
³ Heating Capacity at Air temp. 7 °C / 6 °C, Water in/out temp. 26 °C / 28 °C

After-sale service

If your hot water heater can not operate normally, please turn off the unit and cut off the power supply at once, then contact with our service center or technical department.
